

Lamp Replacement

- SWITCH OFF THE POWER TO THE RANGEHOOD
- USE A SMALL BLADE SCREWDRIVER TO PRIZE OFF THE LIGHT COVER (NOTE SLOT)
- USE A CLOTH TO REMOVE THE BULB. DO NOT TOUCH THE BULB WITH FINGERS
- REPLACE WITH A NEW BULB AND "SNAP" THE COVER BACK IN PLACE
- HALOGEN BULB 12Volts/20Watt

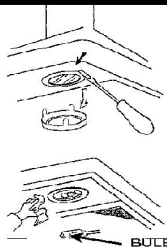

Parts & Service

FILTERS

Aluminium Filter - No. R104163 (Ducted models)

Charcoal Filter No. R104165 (Recirculation models)

The use of charcoal filter is recommended on recirculating model rangehoods.

RECIRCULATING KIT

1752

Kits include

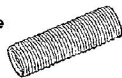

φ150 Flexible ducting



Cable Ties (2)



Top Guide



Charcoal Filters
Three filters

For other Accessories, Parts or Service, please contact your local supplier.
(Refer to the Warranty Certificate)

WARNING

- This appliance is not intended for use by young children or infirm persons without supervision.
- Young children should be supervised to ensure that they do not play with the appliance.
- There shall be adequate ventilation of the room when the rangehood is used at the same time as appliances burning gas or other fuels.
- You must read the details concerning the method and frequency of cleaning.
- There is a fire risk if cleaning is not carried out in accordance with the instructions.
- Do not flambé under the rangehood.
- Exhaust air must not be discharged into an existing flue which is used for exhausting fumes from appliances burning gas or other fuels.
- The minimum distance between the hob surface and the lowest part of the rangehood is 600mm. This distance shall be at least 650mm (recommended 700mm) if the rangehood is installed over a gas hob.
- Attention should be given to ensure that any applicable regulations concerning the discharge of exhaust air is fulfilled.
- If the supply cord of this equipment is damaged, it must only be replaced by the manufacturer or its service agent or similarly qualified person in order to avoid a hazard.

Electrical Rating:
295W (1.23A) Max. at 240V 50Hz

UNIDUCT
RANGEHOOD DUCTING

RECOMMENDED DUCTING SYSTEMS
FOR RANGEHOODS

Fisher and Paykel

INSTALLATION INSTRUCTION

87764 - APEX MODEL
RH900CQ

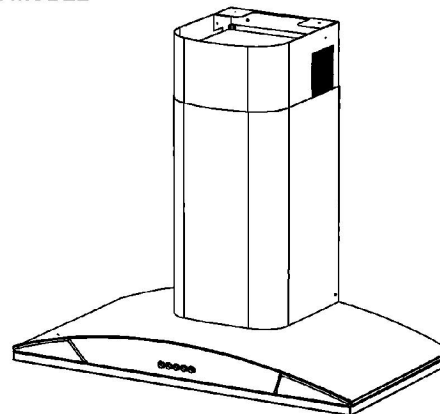

PRODUCT DIMENSIONS

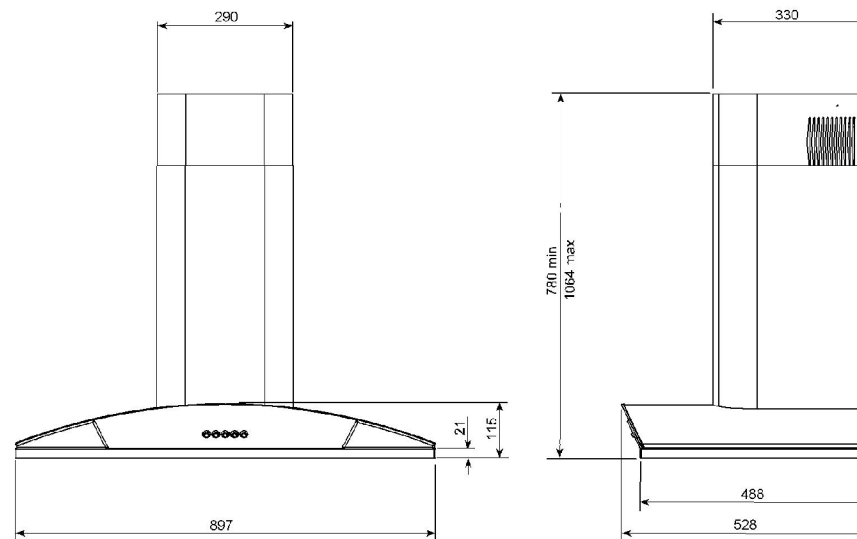

All Dimensions in mm

CANOPY OPERATION

Thank you for purchasing a quality stainless steel canopy rangehood. We have a high standard of quality control and each rangehood is tested and approved before it leaves the factory.

IMPORTANT: Please read prior to installation or operation

- Always switch power off prior to installing, servicing or cleaning the appliance.
- Never use the appliance without filters.
- Please read the notes on general cleaning, especially the filters.
- Exhaust air must not be discharged into a heating flue or wall cavity, unless the cavity is designed for that purpose.
- Areas where the rangehood is installed that also have gas, oil or coal fired heaters, must be well ventilated to prevent a partial vacuum in the room. This includes gas hobs. (A partial vacuum in the room could result in too high a concentration of gas in the atmosphere).
- The appliance is supplied with an approved power cable which must not be changed. If the supply cord of this equipment is damaged, it must only be replaced by the manufacturer or its service agent or similarly qualified person in order to avoid hazard.

MAINTENANCE

Particular care must be taken with grease filters which must be periodically cleaned (at least every two months). Remove the grease filters and wash them either by hand or in the dishwasher using mild detergent. Use lukewarm water and mild detergent to clean stainless steel components. In high humidity and coastal environments, cleaning should be carried out frequently.

CAUTION: Never use products containing abrasive liquid cleaners etc.

USE

Care and attention should always be taken when cooking with oils, alcohol, etc; which give off flammable vapours.

Pre-used oil is especially dangerous in this respect.

Do not use uncovered electrical grill.

To avoid possible risks of fire always comply with the maintenance instruction above.

When making the electrical connection, check that the socket has an earth connection and that the voltage values correspond to those indicated on the rating plate inside the appliance. The power socket connection is to be easily accessible after installation.

CONTROL PANEL

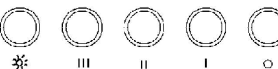

- | | | |
|--------------------|---|---------------------|
| Left Push Button | = | Fan Off |
| Second Push Button | = | Fan On Low Speed |
| Third Push Button | = | Fan On Second Speed |
| Fourth Push Button | = | Fan On High Speed |
| Fifth Push Button | = | Light On/Off Switch |

INSTALLATION OF UNIT

(Read in conjunction with the following diagrams)

The unit is designed for 2.4 to 2.65 metre high ceiling. The decorative chimney cover is telescopic and is designed for 665 to 950mm adjustment.

Note: Ducting accessories are not supplied. Please refer to the optional ducting kits. The air outlet from the motor requires 150mm round ducting which requires 160mm diameter round hole in the ceiling. This hole will be covered by the decorative chimney. Care should be taken to align canopy with decorative chimney allowing sufficient clearance to accommodate the flexible ducting.

Before starting assembly, read the Instructions carefully and remove the filters from canopy to allow access to wall mounting holes. To remove the filters, push the relative catch inward and tilting it downwards until it disengages from the supports. Reverse these instructions when refitting the filters.

NOTE: Stainless steel is very easily damaged during installation if abraded or knocked by tools.

INSTALLATION OF THE UNIT

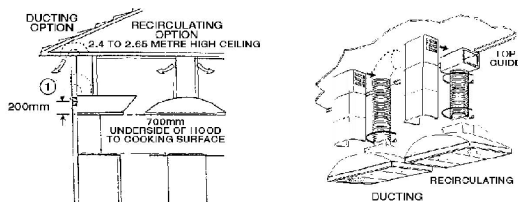

WARNING: The distance between the hob and the mounting holes of the canopy to be at least 900mm to ensure that the fully installed canopy has a clearance of 700mm (recommended height) between the lower part of the hood and the cooking hob. Before drilling any holes check the wall and the ceiling are clear of any electrical cables, pipes etc. Fixing to a solid stud is recommended. ①

Fix the mounting washers in position shown in diagram. ① Check with spirit level across the washers to ensure they are level.

INSTALLING DUCTING

NOTE: All ducting must comply with local requirements and building codes. Mark the position of decorative chimney at ceiling and wall, cut cornice moulding away if necessary to enable panels to fit flat against the wall and ceiling. ② Mark and cut the hole in the ceiling to fit the ducting (155 to 160mm dia). ③ This is positioned centrally with the canopy and 100mm from the wall.

INSTALLING CEILING BRACKET

Using the supplied screws, fix the ceiling bracket ④ to the wall, checking that it is aligned with the hood.

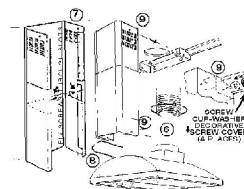
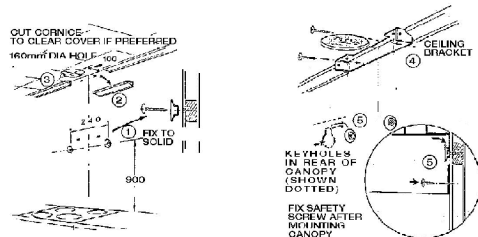

FINAL ASSEMBLY

Remove protective plastic covering from all parts including filters. Now fit the canopy on the fixed mounting washers. ⑤ Plug in power cord at power supply. Check function of rangehood light and motor, before continuing assembly. Fix safety screw ⑤ connect 150mm ducting ⑥ to top of motor flange secure with cable tie. Assemble the telescopic ducting covers (chimney) ⑦ to accurately suit the dimension required, ⑧ fit black plastic extrusion to the base of the chimney and cut to length. ⑨ Mounting screws and plastic cover caps are applied on top and bottom of the chimney.